



Surface Measurement Systems  
World Leader in Sorption Science

# DVS Carbon

CO<sub>2</sub> and H<sub>2</sub>O Gravimetric Sorption Analyzer  
Under Real World Conditions



Gravimetric precision and humidity control for applications in carbon capture, utilization, and storage.

# DVS Carbon

## The world's most advanced gravimetric CO<sub>2</sub> capture analyzer

The latest addition to the DVS family, the DVS Carbon is the first purpose-built gravimetric sorption analyzer for advanced carbon capture conditions. In most gas phase carbon capture applications, CO<sub>2</sub> often competes with other chemical species at adsorbent sites, especially water vapor. The new DVS Carbon enables the measurement of CO<sub>2</sub> uptake in real life conditions, controlling both temperature and humidity at a broad range of CO<sub>2</sub> concentrations.

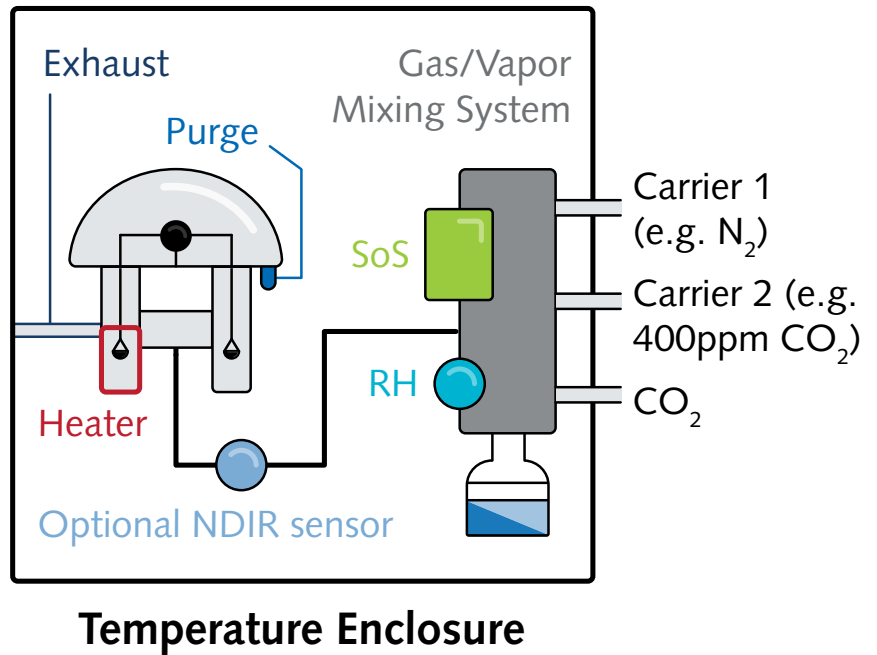

### Carbon Capture, Utilization, & Storage (CCUS) Applications:



Post-combustion capture (PCC)

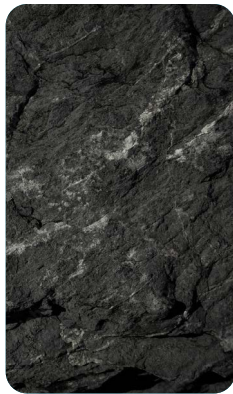

Carbon sequestration

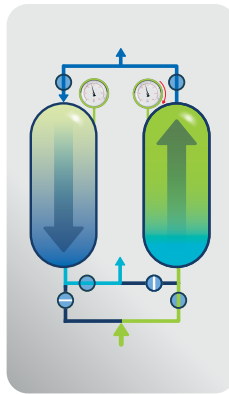

Temperature/moisture swing sorption



Direct air capture (DAC)



Solid sorbent characterization

### What is DVS?

**Dynamic Vapor Sorption (DVS)** is a gravimetric sorption technique that monitors sample mass change across varying concentrations to measure how quickly and how much of a gas or vapor is sorbed by a sample. Learn more on the back cover.

# Key Features

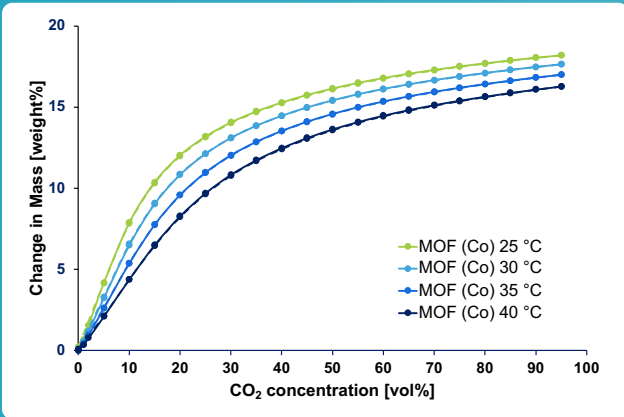

Figure 1: CO<sub>2</sub> uptake as a function of temperature for a Cobalt-based MOF sample. Adsorption and desorption are seen as fully reversible.

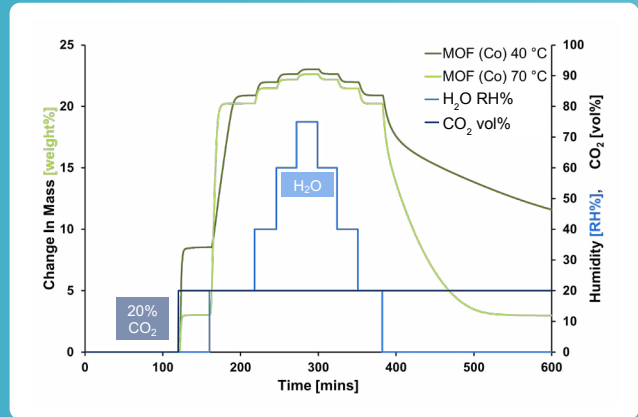

Figure 2: Co-sorption of water at 40 °C and 70 °C in the presence of 20 vol% CO<sub>2</sub>. Total capacity is not affected by experimental temperature.

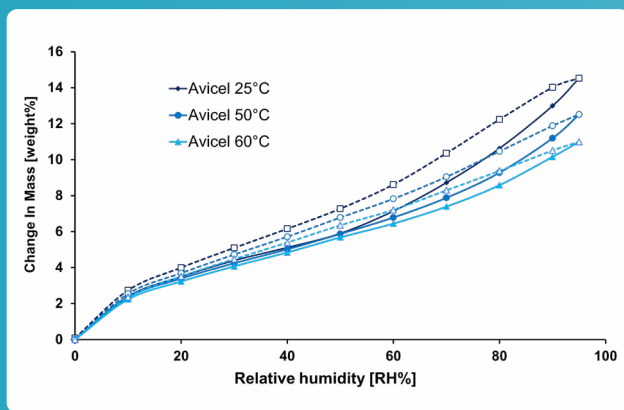

Figure 3: Isotherms of water on a hydrophobic support at increasing temperatures.

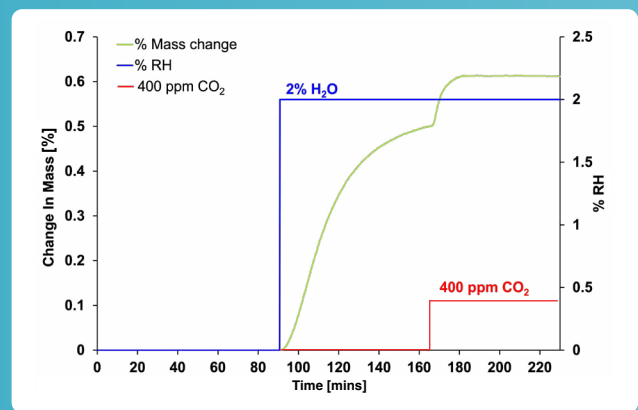

Figure 4: Kinetic plot of CO<sub>2</sub> uptake at atmospheric levels of an amine functionalized carbon, with 2% background of relative humidity. A noticeable increase in mass is observed when 400 ppm CO<sub>2</sub> is introduced.

## Independent multicomponent control

- Concentration of CO<sub>2</sub> and H<sub>2</sub>O can be individually controlled
- Cycling or complex sorption programs are easily created
- Concentration and temperature changed in precise steps or ramps (Fig 2 & 4)

## Isotherms of CO<sub>2</sub> and H<sub>2</sub>O

- CO<sub>2</sub> (Fig 1) and water isotherms (Fig 3) in realistic conditions
- Kinetics for each step available by default

## Multiple concentration & temperature ranges for all CCUS applications

- High percent level (Fig 2) or low ppm range (Fig 4) CO<sub>2</sub> can be controlled, suitable for DAC, PCC, or other CCUS conditions
- Lower CO<sub>2</sub> concentrations (e.g. 400 ppm) are generated using a pre-diluted gas cylinder

## In-situ activation and regeneration

- Sample can be locally heated up to 300° C under inert or process gas
- Drying, activation, or regeneration kinetics determined directly

## Balance, Temperature, and Humidity Stability

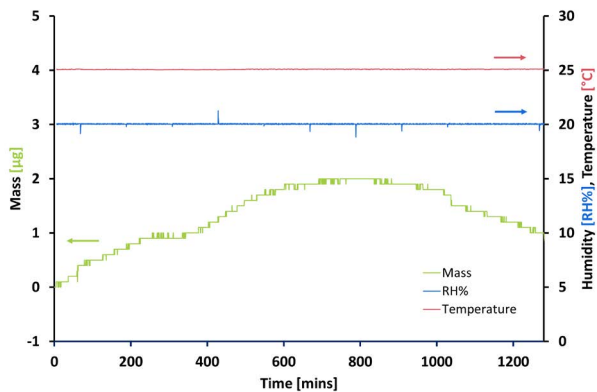

Figure 5: Baseline at 20% RH over 24 hours

The SMS UltraBalance is a custom-built symmetric microbalance that measures microgram changes in sample weight. Temperature control ensures long-term stability, even under dry and humid conditions.

- Mass changes at a resolution of 0.01 µg (for low mass balance)
- Root mean square noise of  $\leq 0.3$  µg for low mass balance (averaged over 24 hours)

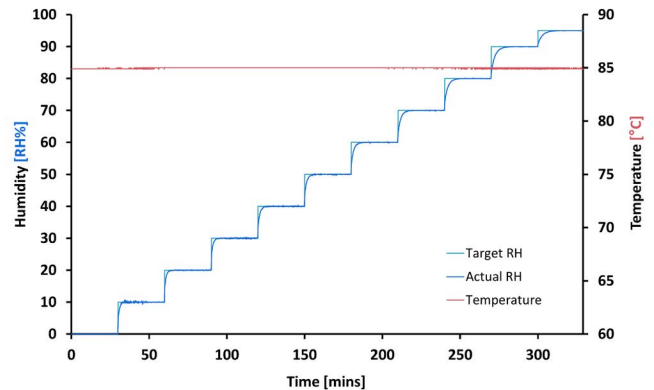

Figure 6: Stability and range of humidity generation at 85 °C

An advanced mixing system and calibrated mass flow controllers enable the DVS Carbon to generate accurate concentrations of CO<sub>2</sub> and humidity.

- Factory-calibrated with salt at 25 °C and 70 °C
- Achieves high humidity (<85%), even at high temperatures (<85 °C), without condensation
- Accurate humidity control with 0.1% RH stability over 6 hours
- Large 500 mL heated water reservoirs

## Humidity and CO<sub>2</sub> Range

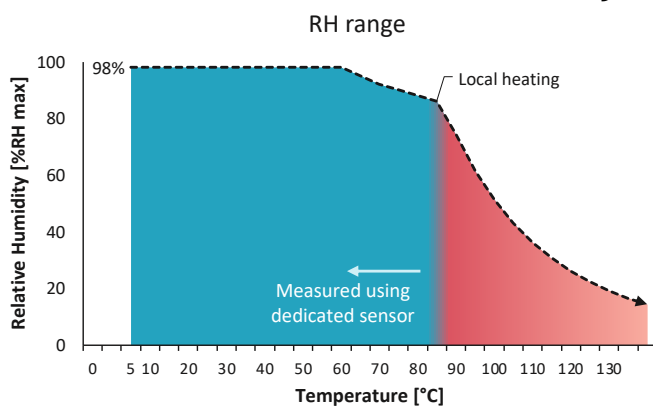

Figure 7: Accessible humidity as a function of temperature

Thanks to a precisely tuned temperature enclosure, heated water reservoirs, and calibrated sensors, accurate high relative humidity is achievable in the enclosure operating temperature range.

An extended range of reduced RH is accessible using local heating up to 300 °C.

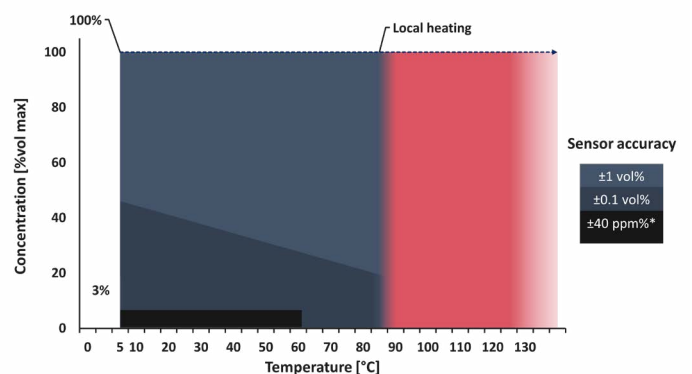

Figure 8: Accessible CO<sub>2</sub> concentration as a function of temperature  
\* Requires DVS Carbon Advanced

CO<sub>2</sub> concentrations can be generated by mixing pure CO<sub>2</sub> with a carrier gas.

Our patented SoS sensor affords accurate measurements with CO<sub>2</sub> concentrations up to 100 vol%, and an increased resolution below 50%. A non-dispersive infrared (NDIR) sensor can be installed for measuring CO<sub>2</sub> down to 50 ppm.

# Speed of Sound Sensor

The speed of sound is an intrinsic property of gas or vapor measured in sorption experiments. It depends on gas/vapor temperature, concentration, and species. Surface Measurement Systems redesigned its patented Speed of Sound (SoS) Sensor to provide the most accurate real-time precision. Meaning this compact device enables controlled generation across a range of concentrations, without the need for large, complex machinery.

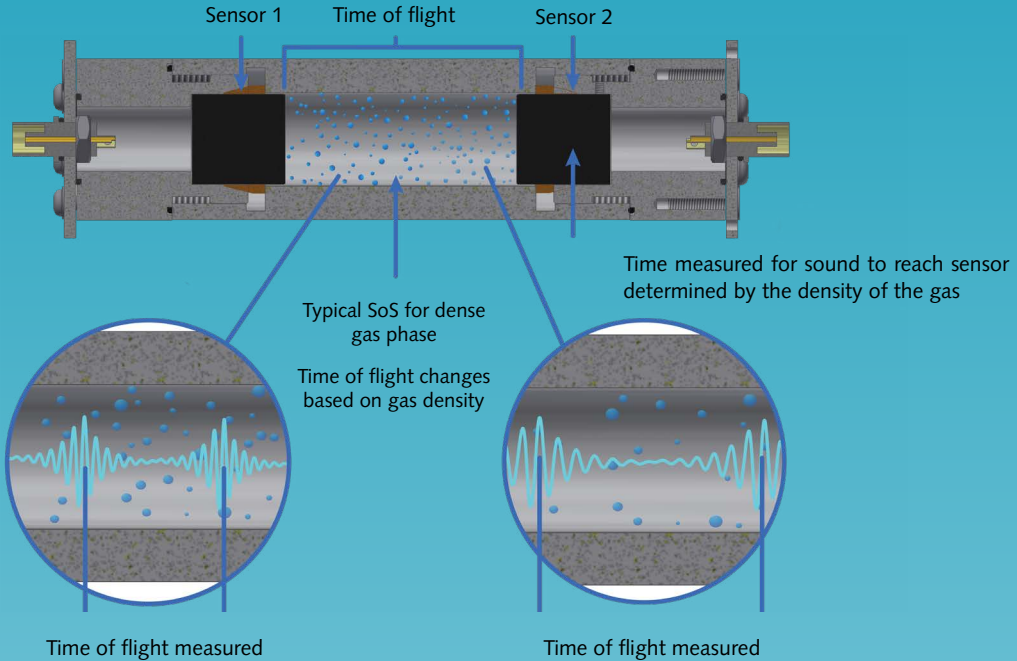

## Comparing DVS Carbon Models

	DVS Carbon Standard	DVS Carbon Advanced
Generate 100 vol% CO <sub>2</sub> by CO <sub>2</sub> & carrier gas mixing, measured by SMS patented Speed of Sound Sensor	✓	✓
Humidity generation up to 98 RH% across wide temperature range with heated water reservoirs	✓	✓
Sample activation or high temperature sorption experiments up to 300 °C with local heater	✓	✓
Seamless carrier gas switching * (e.g. between pure nitrogen and 400 ppm CO <sub>2</sub> in N <sub>2</sub> )	✓	✓
Generation of CO <sub>2</sub> and H <sub>2</sub> O mixtures in a carrier gas, in subject to limits of individual component concentration [vol%CO <sub>2</sub> + RH%] < 100	✓	✓
Mixing capabilities for low concentrations of CO <sub>2</sub> (e.g. 50 ppm to 1000 ppm) **, including a second NDIR CO <sub>2</sub> sensor*** for ppm CO <sub>2</sub> levels		✓
Independent dynamic control & mixing of CO <sub>2</sub> and H <sub>2</sub> O to enable greatly extended CO <sub>2</sub> /RH generation (e.g. increasing CO <sub>2</sub> concentration from 0 to 100% at a constant 50% water saturation)		✓

\* Sensor accuracy is unspecified on carrier gases that contain less than 99% N<sub>2</sub> or air, \*\* Requires pre-calibrated CO<sub>2</sub> cylinder, \*\*\* 2nd NDIR sensor limits max. temp. to 60°C when installed

# Case Study: Post Combustion

Zeolite 13X is a sodium-exchanged aluminosilicate zeolite with a faujasite topology and an effective pore size of around 0.9-1 nm. It is often used in industrial gas separations, such as oxygen production, gas drying, or desulfurization. Due to its high uptake of CO<sub>2</sub>, it was investigated for its capture in flue gas conditions. Unfortunately, its extremely high affinity for water means that CO<sub>2</sub> adsorption is inhibited in humid conditions, as H<sub>2</sub>O competes and occupies the micropores.

The DVS Carbon was used to examine the uptakes of two components, and to evaluate the impact of humidity on CO<sub>2</sub> capture. An initial CO<sub>2</sub> isotherm shows a high uptake for carbon dioxide, of nearly 15 weight%.

To evaluate co-adsorption conditions, a second CO<sub>2</sub> isotherm is recorded with 5% RH of background relative humidity. The introduction of CO<sub>2</sub> induces a negligible increase in mass, highlighting that the sorption sites and pores are already occupied by water.

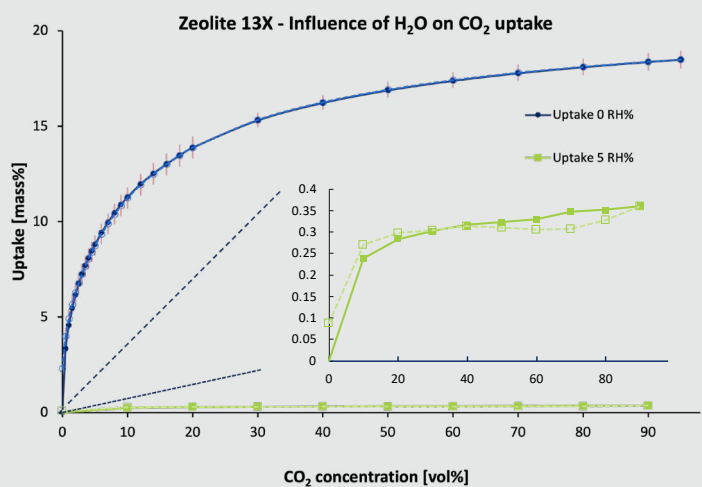

Figure 9: Impact of constant humidity (5 RH%) on CO<sub>2</sub> uptake at 25 °C on Zeolite 13X in a N<sub>2</sub> carrier flow. Inset shows zoom of isotherm on 5 RH%, assuming no displacement of water by CO<sub>2</sub>

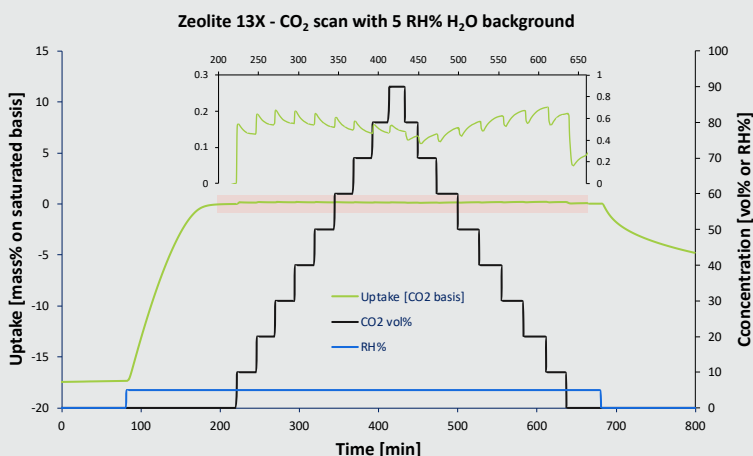

Figure 10: Kinetics of uptake when CO<sub>2</sub> is changed at a constant 5 RH% on Zeolite 13X at 45°C. Inset is a zoom of mass change during CO<sub>2</sub> scanning

Observing the kinetics in detail, a small displacement effect can be observed. Nevertheless, as has been also proven by breakthrough studies, the uptake for CO<sub>2</sub> decreases by a factor of 10. An interesting observation is that the kinetics of water sorption are slow compared to CO<sub>2</sub>. This could allow kinetic-driven, rather than equilibrium-driven separation processes with Zeolite 13X.

# Case Study: Direct Air Capture

Direct air capture (DAC) is an ambitious initiative to capture CO<sub>2</sub> from the ambient air. This endeavour is challenging due to the low concentration of carbon dioxide in the atmosphere, around 400 ppm. Amines are promising for this application due to their high affinity for carbon dioxide. Functionalizing amine groups or impregnating amines on various porous supports helps to mitigate issues such as accessibility, degradation, and vaporization. The influence of water is particularly important, as its presence can reduce or even enhance the capacity for CO<sub>2</sub>.

Uptakes on two different types of supported amines have been evaluated. In one case, humidity was changed in the presence of low concentrations of CO<sub>2</sub> to study total uptakes. In another, steps of each component were introduced, to study in-depth the kinetics of adsorption in the presence of individual and combined components.

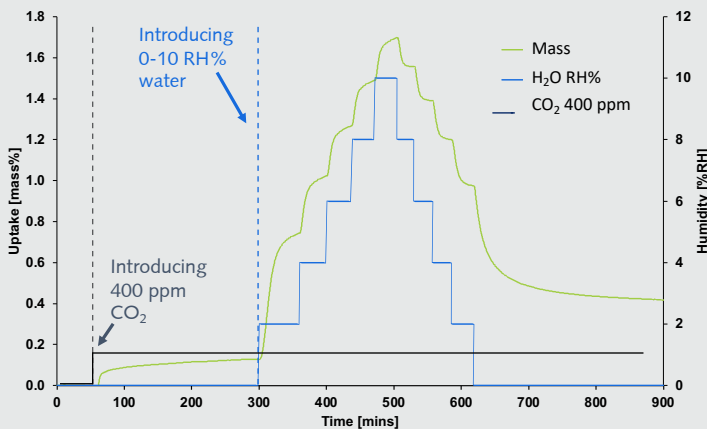

Figure 11: Evaluating total uptake in the presence of humidity and CO<sub>2</sub> on an amine functionalized sorbent

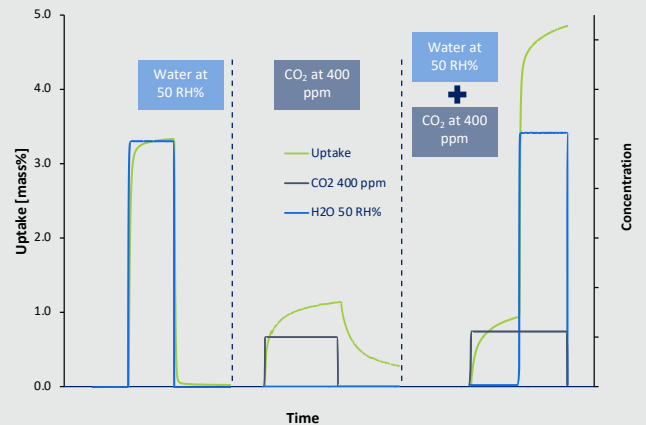

Figure 12: Sequential experiments evaluating kinetics of adsorption during step changes in humidity, 400 ppm CO<sub>2</sub> and both components



The DVS Carbon allows straightforward control of all important variables: CO<sub>2</sub> concentration, humidity, and temperature.

# Modular Capabilities

## Speed of Sound Sensor

The latest iteration of the SoS sensor is specially developed to enable control and precision in the generation and measurement of CO<sub>2</sub> concentrations, from high (100%) to low (0.5%) at 25 °C.



Speed of Sound Sensor

## Heated Reservoir

- The heated reservoir is located in the temperature enclosure
- Designed for extended humidity generation up to 85°C, with fully automated temperature control
- Features a heated jacket to avoid evaporative cooling

## High Temperature Preheater

(For drying and regeneration)

- *In-situ* degassing/activation of samples up to 300 °C
- The temperature is measured by a Pt-100 directly below the sample pan
- User programmable and controlled temperature ramps or steps

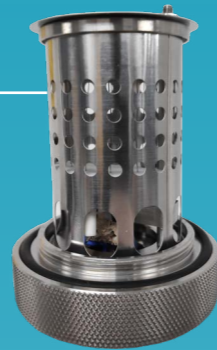

## Optional:

### Raman Spectroscopy

- Fully integrated hardware/software solution for triggering and capturing Raman spectra during sorption experiments

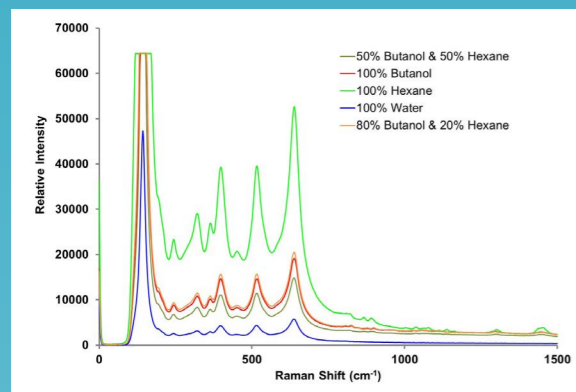

Figure 13. Raman spectra of single and dual-solvents sorption of butanol and hexane for a titanium oxide sample at 25 °C

### Microscopy and Video

- 1.3 megapixel color camera and up to 200x optical zoom



Raman probe observing samples during measurements

Figure 14. In-situ monolith support

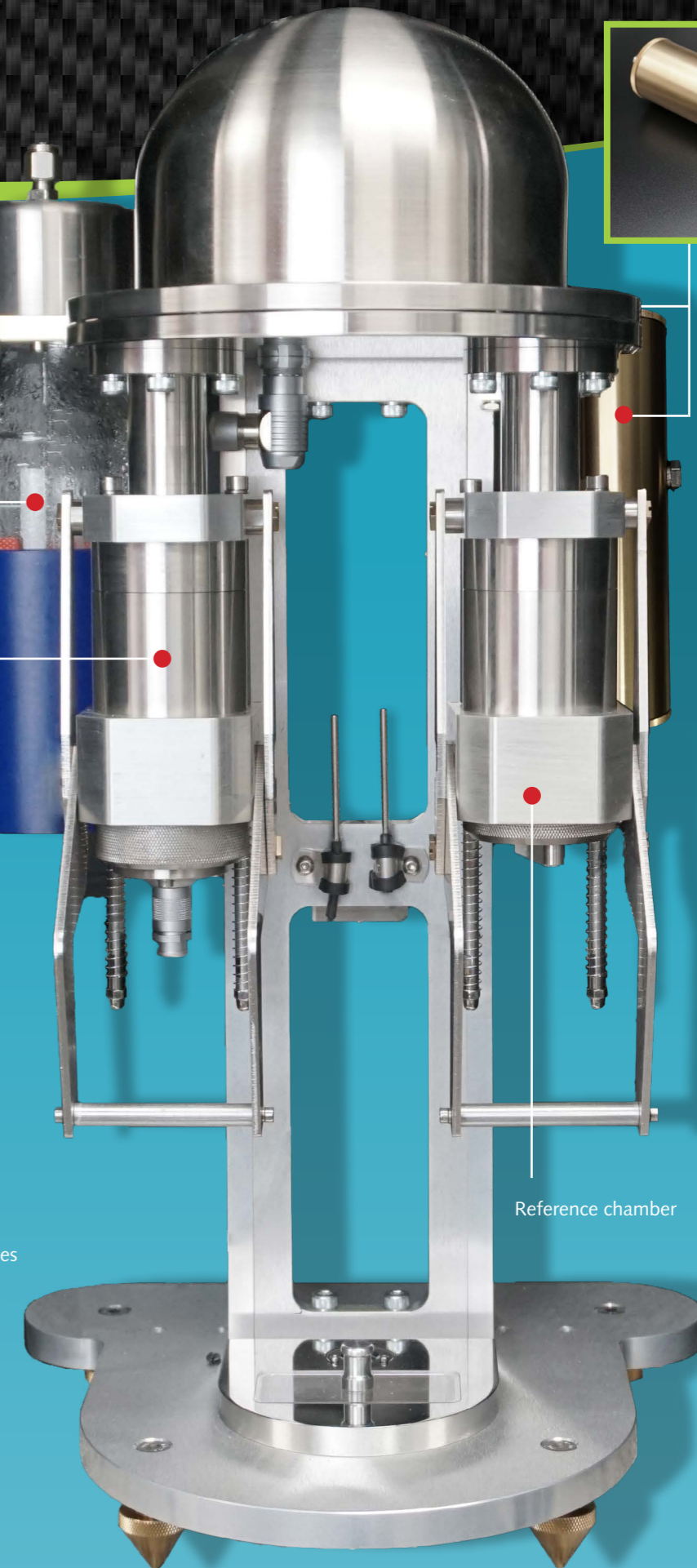

Reference chamber

Important: Camera and Raman cannot be used while the Preheater is mounted to the chamber



# Purpose-built Software

The software package provided with the DVS Carbon allows the users to create and customize experimental methods while enabling the full analysis of the kinetic data collected. Examples of the control and analysis software used in two sorption experiments are outlined below.

## Control Software

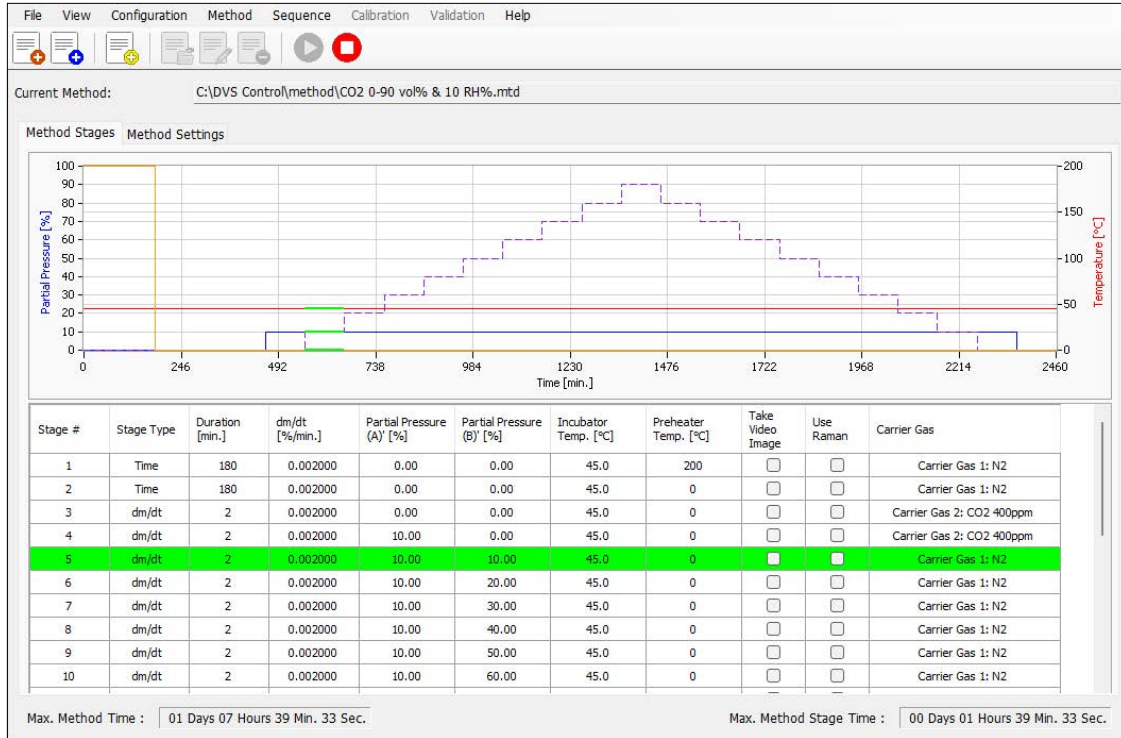

Figure 15. The above graph shows the method panel within the method manager. It displays numerically and graphically the current method for a water and CO<sub>2</sub> sorption experiment at 25 °C. The active stage of the ongoing experiment is highlighted in green. Figures 16 and 17 (below) are typical data generated by this method.

## Analysis Software

### Sorption Data

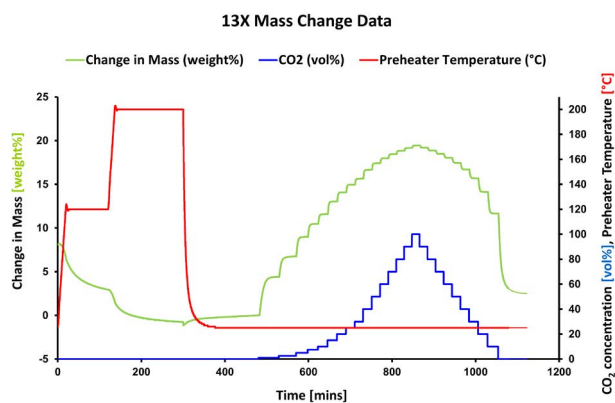

Figure 16. Sample activation and CO<sub>2</sub> sorption kinetics of zeolite 13X at 25 °C

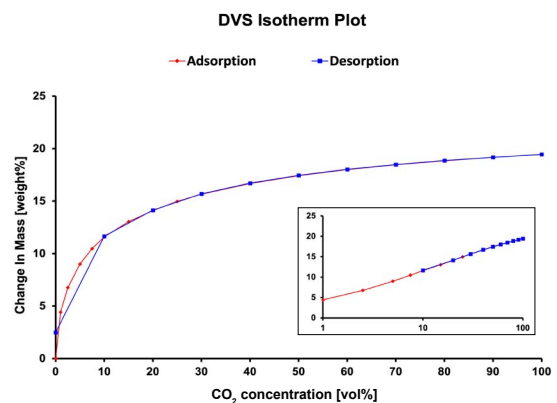

Figure 17. CO<sub>2</sub> sorption isotherm of zeolite 13X at 25 °C

# Specifications

## Construction Materials

Custom built manifold: 316 stainless steel  
Seals: Viton® and Kalrez® or equivalent  
Tubing: 1/4 inch 316 stainless steel

## Gas Flow Control

High accuracy digital mass flow controllers  
Wide dynamic range - turndown ratio 1000:1  
Carrier gas: dry air, nitrogen, CO<sub>2</sub> (<1%) in nitrogen

## Temperature Control

### Temperature controlled enclosure

Contains entire generation and measurement system  
Control range: 5 °C to 85 °C  
Temperature stability ± 0.05 °C over 6 hours  
Temperature resolution 0.01 °C

### Local sample heater

Control range: up to 300 °C  
Heating ramp rates: up to 10 °C/min

## Humidity Generation & Measurement

### Water Reservoirs

500 mL easy-change reservoir  
Heated to avoid evaporative cooling

### Generation

Relative humidity range

- 0 to 98% RH for 5-60 °C<sup>1</sup>
- 0 to 85% RH for 60-85 °C<sup>1</sup>

Relative humidity generation performance

- Accuracy: ±0.5% RH<sup>2</sup>
- Resolution: ±0.1% RH
- Stability: ±0.1% RH over 6 hours

### Measurement

Relative humidity continuous measurement

- Range 0-100%RH

Relative humidity measurement accuracy

- ±0.8% RH at 5-40 °C
- ±1.5% RH at 40-85 °C

## CO<sub>2</sub> Generation and Measurement

### Generation

Concentration range 0-100% vol, atmospheric pressure

CO<sub>2</sub> generation performance

- Accuracy: exact<sup>3</sup> or 0.5% vol of inlet concentration<sup>4</sup>

### Measurement

Patented Speed of Sound Sensor

- Range: 0-100% vol<sup>5</sup>
- Accuracy: 0.1% vol up to 40% vol, 1% above

In line NDIR ppm sensor<sup>6,7</sup>

- Range 0-3% vol
- Accuracy: 40 ppm<sup>5</sup>

## Weight Measurement

### Ultrabalance Low Mass

Maximum load: 1000 mg  
Mass change: ±150 mg  
Resolution: 0.01 µg  
Balance noise: ≤ 0.3 µg<sup>8</sup>

### Ultrabalance High Mass

Maximum load: 5000 mg  
Mass change: ±1000 mg  
Resolution: 0.1 µg  
Balance noise: ≤ 3 µg<sup>8</sup>

## Hardware Configuration

### Standard

Mixing of two gas streams, with controlled humidity and CO<sub>2</sub> concentration, respectively<sup>9</sup>

Switching between different carrier gases e.g. Nitrogen and 400 ppm CO<sub>2</sub>

### Advanced

Two heated reservoirs for enhanced humidity generation at high CO<sub>2</sub> levels (up to 98% humidity in a pure CO<sub>2</sub> stream)<sup>9</sup>

Mixing and direct measurement of low CO<sub>2</sub> concentrations (ppm-level) through dedicated instrumentation<sup>9</sup>

## System Information

**Dimensions:** 520 mm (W) x 980 mm (H) x 610 mm (D)

**Weight:** 80 kg (180 lb)

**Electrical:** 200-240 V, 50/60 Hz, 1500 VA

## System Software

### DVS Control Software

- Live data view and plotting
- Full control over all parameters
- Powerful custom methods and sequences
- Complex isotherm or isobar experiments
- Temperature changes in a single experiment
- Ramp or step methods available
- Intelligent (dm/dt) or time-based step equilibration criteria
- Multiple concentration or temperature cycles
- Automated video image or Raman spectra acquisition

### DVS Analysis Software

- Automated isotherm calculation
- Full kinetics information during experiment
- Isotherm modeling
- Enthalpy (heat) of adsorption
- Permeability and diffusion modeling
- Surface area models

### Software Options:

#### Standard (Included)

- Control software
- Standard analysis

#### Advanced (Optional)

- Advanced analysis suite
- Isotherm analysis suite

#### Footnotes

<sup>1</sup> Humidity factory calibrated at 25 °C and 70 °C. Calibrations at other temperatures upon request

<sup>2</sup> 1-σ confidence level with % RH based on SMS factory certified methods (Salt Calibration)

<sup>3</sup> When using pure CO<sub>2</sub> or a calibrated cylinder

<sup>4</sup> When mixing

<sup>5</sup> At 25 °C

<sup>6</sup> Only in advanced configuration

<sup>7</sup> Using ppm probe reduces maximum operating T to 60 °C

<sup>8</sup> Root mean square (averaged over 24 hours)

<sup>9</sup> Some measurement restrictions apply

## What is Dynamic Vapor Sorption?

Invented by Professor Daryl Williams, Founder & MD of Surface Measurement Systems, Dynamic Vapor Sorption (DVS) is a gravimetric sorption technique that measures how quickly and how much of a vapor or gas is sorbed by a sample. It does this by varying the vapor/gas concentration around the sample and measuring the resultant change in mass. DVS is a valued tool in R&D laboratories all over the world, from pharmaceutical, food, personal care and health to energy, aerospace, agriculture, environmental, and building material industries.

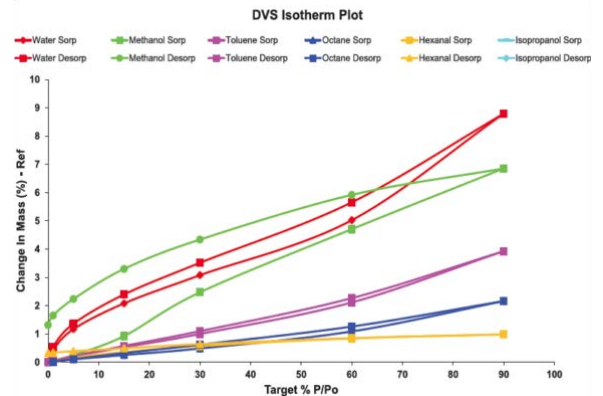

## About Surface Measurement Systems

Surface Measurement Systems Ltd. develops and engineers innovative experimental techniques and instrumentation for physico-chemical characterization of complex solids, solving difficult problems in materials research. With over 30 years of continuous innovation, every instrument is built with the cumulative knowledge and experience of our world-leading team of sorption scientists. This makes us the preferred sorption partner of universities, research institutes, corporate R&D, and global government organizations, who we work with and support in pioneering the future of materials research.



[sales@surfacemeasurementsystems.com](mailto:sales@surfacemeasurementsystems.com) • [www.surfacemeasurementsystems.com](http://www.surfacemeasurementsystems.com)

UK | USA | India | China | Germany